

7. If reusing the original chain, service it as required, then connect it to the old chain and pull it around the front sprocket. Disconnect the chains.
8. Install by reversing the preceding removal steps while noting the following:
 - a. On an O-ring chain, install the four O-rings onto the master link as shown in Figure 41, typical.

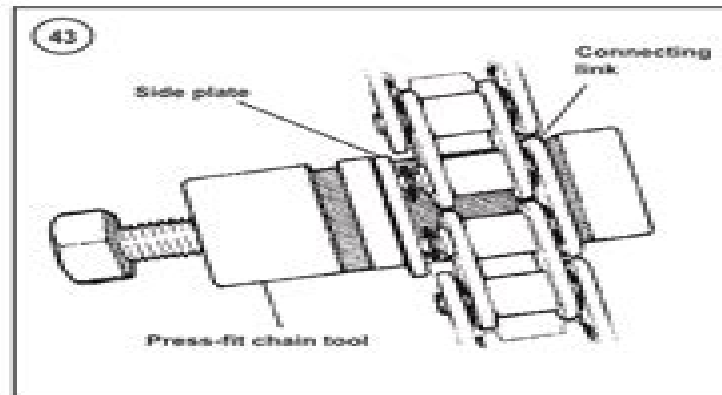

- b. If assembling the chain using a press fit master link, refer to *Press Fit Master Link* in this section to press the side plate onto the connecting link.
- c. Install the spring clip onto the master link so the closed end of the clip faces the direction of chain travel (Figure 42).
- d. Lubricate and adjust the drive chain as described in Chapter Three.

Press Fit Master Link

CAUTION

Attempting to install a press-fit master link without the proper tools can damage the master link and parts of the chain.

NOTE

Most commercial press-fit chain tools are designed to press the side plate onto the connecting link to its correct depth. If the side plate is pressed on too far, it will bind the chain where it is joined at the master link. If the side plate is not pressed on far enough, the spring clip cannot be installed correctly and will probably come off. Properly installed, the side plate is flush with both pin seating grooves in the connecting link.

Many drive chains are equipped with a master link side plate that is pressed into place. To install this type of master link, a press-fit chain tool is required; Figure 43 illustrates one type of chain press tool. To disconnect the chain, first remove the outer clip from the master link, then use a chain breaker to separate the side plate from the connecting link.

1986 2015 Harley Davidson Sportster Motorcycle Service Manuals

Ron Wright



1986 2015 Harley Davidson Sportster Motorcycle Service Manuals:

Harley-Davidson XL/XLH Sportster 1986-2003 Penton Staff,2000-05-24 XLH883 XL883R XLH1100 XL XLH1200

Harley-Davidson Ron Wright,1991 **Service Manual** Harley-Davidson Motor Company,1987 **1986 to 1990 XLH**

Models Service Manual Harley-Davidson Motor Company,1989 **Harley-Davidson Sportster Motorcycle Repair**

Manual Curt Choate, Tom Schauwecker, John Harold Haynes,1990 1984 to 1986 FLT/FXR 1340cc 5-speed Service

Manual Harley-Davidson Motor Company,1985 **Harley-Davidson** Clymer Publishing,Ron Wright,Alan Ahlstrand,1990

Harley-Davidson Sportster Owners Workshop Manual Tom Schauwecker,John Harold Haynes,1983-01-01

Harley-Davidson Sportsters Owners Workshop Manual Curt Choate, Tom Schauwecker, John Harold Haynes,1999 Harley Davidson Sportsters 1970 1999 Repair Manual Haynes Covers 883cc 997cc 11cc and 12cc engines Sftbd 8 1 2x 11 3 4 2 pgs

48 b w ill Harley-Davidson XL Sportster 2014-2017 Clymer Publications,2018-05-01 Each Clymer manual provides specific and detailed instructions for performing everything from basic maintenance and troubleshooting to a complete overhaul of the machine This manual covers the Harley Davidson XL Sportster built from 2014 to 2017 Do it yourselfers will find this service and repair manual more comprehensive than the factory manual making it an indispensable part of their toolbox Specific models covered include XL883L SuperLow 2014 2017 XL883N Iron 883 2014 2017 XL883R Roadster 2014 2015 XL1200C 1200 Custom 2014 2017 XL1200CA Custom Limited A 2014 2016 XL1200CB 1200 Custom Limited B 2014 2017 XL1200CP 1200 Custom factory custom 2014 2016 XL1200CX Roadster 2016 2017 XL1200T SuperLow 2014 2017 XL1200V Seventy Two 2014 2016 and XL1200X Forty Eight 2014 2017 *Clymer Harley-Davidson Sportsters 1959-1985* Penton

Staff,1985-02-01 Harley Davidson Sportsters are very popular machines built with precision engineering to ensure a long life on the road With the help of the Clymer Harley Davidson Sportsters 1959 1985 Repair Manual in your toolbox you will be able to maintain service and repair your Harley Davidson Sportster to extend its life for years to come Clymer manuals are very well known for their thorough and comprehensive nature This manual is loaded with step by step procedures along with detailed photography exploded views charts and diagrams to enhance the steps associated with a service or repair task This Clymer manual is organized by subsystem with procedures grouped together for specific topics such as front suspension brake system engine and transmission It includes color wiring diagrams The language used in this Clymer repair manual is targeted toward the novice mechanic but is also very valuable for the experienced mechanic The service manual by Clymer is an authoritative piece of DIY literature and should provide you the confidence you need to get the job done and save money too

Harley-Davidson Sportster '70 to '13 John Haynes,2016-05-01 Complete coverage for your Harley Davidson Sportster for 1970 to 2013 covering Routine Maintenance and servicing Tune up procedures Engine clutch and transmission repair Cooling system Fuel and exhaust Ignition and electrical systems Brakes wheels and tires Steering suspension and final drive Frame and bodywork Wiring diagrams Reference Section With a Haynes manual you can do it yourself from simple

maintenance to basic repairs Haynes writes every book based on a complete teardown of the motorcycle We learn the best ways to do a job and that makes it quicker easier and cheaper for you Our books have clear instructions and hundreds of photographs that show each step Whether you re a beginner or a pro you can save big with Haynes Step by step procedures Easy to follow photos Complete troubleshooting section Valuable short cuts Model history and pre ride checks in color Color spark plug diagnosis and wiring diagrams Tools and workshop tips section in color *Harley-Davidson Sportster* John H Haynes,John Haynes,2015-06-15 Complete coverage for your Harley Davidson Sportster for 1970 thru 2010 covering XL XLH XLCH XLS and XLX with 883 1000 1100 and 1200 engines Does not include XR 1000 engine information or 2009 on XR models Routine Maintenance and servicing Tune up procedures Engine clutch and transmission repair Cooling system Fuel and exhaust Ignition and electrical systems Brakes wheels and tires Steering suspension and final drive Frame and bodywork Wiring diagrams Reference Section With a Haynes manual you can do it yourself from simple maintenance to basic repairs Haynes writes every book based on a complete teardown of the motorcycle We learn the best ways to do a job and that makes it quicker easier and cheaper for you Our books have clear instructions and hundreds of photographs that show each step Whether you re a beginner or a pro you can save big with Haynes Step by step procedures Easy to follow photos Complete troubleshooting section Valuable short cuts Model history and pre ride checks in color Color spark plug diagnosis and wiring diagrams Tools workshop tips section in color Harley-Davidson Sportsters Owners Workshop Manual Jeff Clew,1976-01-01 **1970-72 Sportster Service Manual** Harley-Davidson Motor Company,1971 **Clymer Harley-Davidson Shovelheads 66-84: Service, Repair, Maintenance** Ron Wright,1992-09-01 Clymer motorcycle repair manuals can save you money on maintenance and repair bills Step by step procedures and detailed illustrations guide you through every job from maintenance and troubleshooting all the way to complete teardown and rebuild General information Troubleshooting Tune up and routine maintenance Engines Clutch Transmission and gearshift mechanisms Fuel injection system emissions controls and exhaust systems Electrical system Cooling system Front suspension and steering Rear suspension and final drive Brakes Frame body and frame repainting Supplements Wiring Diagrams *Harley-Davidson Service Manual* Harley-Davidson Motor Company,1976* **1959 to 1969 Sportster Service Manual** Harley-Davidson Motor Company,1968 Clymer Harley-Davidson H-D Panheads 1948-1965 Penton Staff,1992-06-01 Harley Davidson Panheads are very popular machines built with precision engineering to ensure a long life on the road With the help of the Clymer Harley Davidson H D Panheads 1948 1965 Repair Manual in your toolbox you will be able to maintain service and repair your vintage motorcycle to extend its life for years to come Clymer manuals are very well known for their thorough and comprehensive nature This manual is loaded with step by step procedures along with detailed photography exploded views charts and diagrams to enhance the steps associated with a service or repair task This Clymer manual is organized by subsystem with procedures grouped together for specific topics such as front suspension brake system engine and

transmission It includes color wiring diagrams The language used in this Clymer repair manual is targeted toward the novice mechanic but is also very valuable for the experienced mechanic The service manual by Clymer is an authoritative piece of DIY literature and should provide you the confidence you need to get the job done and save money too *Clymer Harley-Davidson Sportsters 1959-1985* Penton Staff,1985-02-01 Harley Davidson Sportsters are very popular machines built with precision engineering to ensure a long life on the road With the help of the Clymer Harley Davidson Sportsters 1959 1985 Repair Manual in your toolbox you will be able to maintain service and repair your Harley Davidson Sportster to extend its life for years to come Clymer manuals are very well known for their thorough and comprehensive nature This manual is loaded with step by step procedures along with detailed photography exploded views charts and diagrams to enhance the steps associated with a service or repair task This Clymer manual is organized by subsystem with procedures grouped together for specific topics such as front suspension brake system engine and transmission It includes color wiring diagrams The language used in this Clymer repair manual is targeted toward the novice mechanic but is also very valuable for the experienced mechanic The service manual by Clymer is an authoritative piece of DIY literature and should provide you the confidence you need to get the job done and save money too

When somebody should go to the books stores, search initiation by shop, shelf by shelf, it is truly problematic. This is why we present the ebook compilations in this website. It will certainly ease you to look guide **1986 2015 Harley Davidson Sportster Motorcycle Service Manuals** as you such as.

By searching the title, publisher, or authors of guide you in fact want, you can discover them rapidly. In the house, workplace, or perhaps in your method can be every best area within net connections. If you direct to download and install the 1986 2015 Harley Davidson Sportster Motorcycle Service Manuals, it is extremely easy then, before currently we extend the colleague to purchase and make bargains to download and install 1986 2015 Harley Davidson Sportster Motorcycle Service Manuals consequently simple!

https://recruitmentslovakia.sk/data/book-search/fetch.php/Link_Belt_Crane_Rt8090_Ii_Service_Manual.pdf

Table of Contents 1986 2015 Harley Davidson Sportster Motorcycle Service Manuals

1. Understanding the eBook 1986 2015 Harley Davidson Sportster Motorcycle Service Manuals
 - The Rise of Digital Reading 1986 2015 Harley Davidson Sportster Motorcycle Service Manuals
 - Advantages of eBooks Over Traditional Books
2. Identifying 1986 2015 Harley Davidson Sportster Motorcycle Service Manuals
 - Exploring Different Genres
 - Considering Fiction vs. Non-Fiction
 - Determining Your Reading Goals
3. Choosing the Right eBook Platform
 - Popular eBook Platforms
 - Features to Look for in an 1986 2015 Harley Davidson Sportster Motorcycle Service Manuals
 - User-Friendly Interface
4. Exploring eBook Recommendations from 1986 2015 Harley Davidson Sportster Motorcycle Service Manuals
 - Personalized Recommendations
 - 1986 2015 Harley Davidson Sportster Motorcycle Service Manuals User Reviews and Ratings

1986 2015 Harley Davidson Sportster Motorcycle Service Manuals

- 1986 2015 Harley Davidson Sportster Motorcycle Service Manuals and Bestseller Lists
- 5. Accessing 1986 2015 Harley Davidson Sportster Motorcycle Service Manuals Free and Paid eBooks
 - 1986 2015 Harley Davidson Sportster Motorcycle Service Manuals Public Domain eBooks
 - 1986 2015 Harley Davidson Sportster Motorcycle Service Manuals eBook Subscription Services
 - 1986 2015 Harley Davidson Sportster Motorcycle Service Manuals Budget-Friendly Options
- 6. Navigating 1986 2015 Harley Davidson Sportster Motorcycle Service Manuals eBook Formats
 - ePub, PDF, MOBI, and More
 - 1986 2015 Harley Davidson Sportster Motorcycle Service Manuals Compatibility with Devices
 - 1986 2015 Harley Davidson Sportster Motorcycle Service Manuals Enhanced eBook Features
- 7. Enhancing Your Reading Experience
 - Adjustable Fonts and Text Sizes of 1986 2015 Harley Davidson Sportster Motorcycle Service Manuals
 - Highlighting and Note-Taking 1986 2015 Harley Davidson Sportster Motorcycle Service Manuals
 - Interactive Elements 1986 2015 Harley Davidson Sportster Motorcycle Service Manuals
- 8. Staying Engaged with 1986 2015 Harley Davidson Sportster Motorcycle Service Manuals
 - Joining Online Reading Communities
 - Participating in Virtual Book Clubs
 - Following Authors and Publishers 1986 2015 Harley Davidson Sportster Motorcycle Service Manuals
- 9. Balancing eBooks and Physical Books 1986 2015 Harley Davidson Sportster Motorcycle Service Manuals
 - Benefits of a Digital Library
 - Creating a Diverse Reading Collection 1986 2015 Harley Davidson Sportster Motorcycle Service Manuals
- 10. Overcoming Reading Challenges
 - Dealing with Digital Eye Strain
 - Minimizing Distractions
 - Managing Screen Time
- 11. Cultivating a Reading Routine 1986 2015 Harley Davidson Sportster Motorcycle Service Manuals
 - Setting Reading Goals 1986 2015 Harley Davidson Sportster Motorcycle Service Manuals
 - Carving Out Dedicated Reading Time
- 12. Sourcing Reliable Information of 1986 2015 Harley Davidson Sportster Motorcycle Service Manuals
 - Fact-Checking eBook Content of 1986 2015 Harley Davidson Sportster Motorcycle Service Manuals
 - Distinguishing Credible Sources

13. Promoting Lifelong Learning
 - Utilizing eBooks for Skill Development
 - Exploring Educational eBooks
14. Embracing eBook Trends
 - Integration of Multimedia Elements
 - Interactive and Gamified eBooks

1986 2015 Harley Davidson Sportster Motorcycle Service Manuals Introduction

In the digital age, access to information has become easier than ever before. The ability to download 1986 2015 Harley Davidson Sportster Motorcycle Service Manuals has revolutionized the way we consume written content. Whether you are a student looking for course material, an avid reader searching for your next favorite book, or a professional seeking research papers, the option to download 1986 2015 Harley Davidson Sportster Motorcycle Service Manuals has opened up a world of possibilities. Downloading 1986 2015 Harley Davidson Sportster Motorcycle Service Manuals provides numerous advantages over physical copies of books and documents. Firstly, it is incredibly convenient. Gone are the days of carrying around heavy textbooks or bulky folders filled with papers. With the click of a button, you can gain immediate access to valuable resources on any device. This convenience allows for efficient studying, researching, and reading on the go. Moreover, the cost-effective nature of downloading 1986 2015 Harley Davidson Sportster Motorcycle Service Manuals has democratized knowledge. Traditional books and academic journals can be expensive, making it difficult for individuals with limited financial resources to access information. By offering free PDF downloads, publishers and authors are enabling a wider audience to benefit from their work. This inclusivity promotes equal opportunities for learning and personal growth. There are numerous websites and platforms where individuals can download 1986 2015 Harley Davidson Sportster Motorcycle Service Manuals. These websites range from academic databases offering research papers and journals to online libraries with an expansive collection of books from various genres. Many authors and publishers also upload their work to specific websites, granting readers access to their content without any charge. These platforms not only provide access to existing literature but also serve as an excellent platform for undiscovered authors to share their work with the world. However, it is essential to be cautious while downloading 1986 2015 Harley Davidson Sportster Motorcycle Service Manuals. Some websites may offer pirated or illegally obtained copies of copyrighted material. Engaging in such activities not only violates copyright laws but also undermines the efforts of authors, publishers, and researchers. To ensure ethical downloading, it is advisable to utilize reputable websites that prioritize the legal distribution of content. When downloading 1986 2015 Harley Davidson Sportster Motorcycle Service Manuals, users should also consider the potential security risks associated with online platforms.

Malicious actors may exploit vulnerabilities in unprotected websites to distribute malware or steal personal information. To protect themselves, individuals should ensure their devices have reliable antivirus software installed and validate the legitimacy of the websites they are downloading from. In conclusion, the ability to download 1986 2015 Harley Davidson Sportster Motorcycle Service Manuals has transformed the way we access information. With the convenience, cost-effectiveness, and accessibility it offers, free PDF downloads have become a popular choice for students, researchers, and book lovers worldwide. However, it is crucial to engage in ethical downloading practices and prioritize personal security when utilizing online platforms. By doing so, individuals can make the most of the vast array of free PDF resources available and embark on a journey of continuous learning and intellectual growth.

FAQs About 1986 2015 Harley Davidson Sportster Motorcycle Service Manuals Books

How do I know which eBook platform is the best for me? Finding the best eBook platform depends on your reading preferences and device compatibility. Research different platforms, read user reviews, and explore their features before making a choice. Are free eBooks of good quality? Yes, many reputable platforms offer high-quality free eBooks, including classics and public domain works. However, make sure to verify the source to ensure the eBook credibility. Can I read eBooks without an eReader? Absolutely! Most eBook platforms offer web-based readers or mobile apps that allow you to read eBooks on your computer, tablet, or smartphone. How do I avoid digital eye strain while reading eBooks? To prevent digital eye strain, take regular breaks, adjust the font size and background color, and ensure proper lighting while reading eBooks. What the advantage of interactive eBooks? Interactive eBooks incorporate multimedia elements, quizzes, and activities, enhancing the reader engagement and providing a more immersive learning experience. 1986 2015 Harley Davidson Sportster Motorcycle Service Manuals is one of the best book in our library for free trial. We provide copy of 1986 2015 Harley Davidson Sportster Motorcycle Service Manuals in digital format, so the resources that you find are reliable. There are also many Ebooks of related with 1986 2015 Harley Davidson Sportster Motorcycle Service Manuals. Where to download 1986 2015 Harley Davidson Sportster Motorcycle Service Manuals online for free? Are you looking for 1986 2015 Harley Davidson Sportster Motorcycle Service Manuals PDF? This is definitely going to save you time and cash in something you should think about.

Find 1986 2015 Harley Davidson Sportster Motorcycle Service Manuals :

link belt crane rt8090 ii service manual

method statement for laying pvc pipes

quizlet biology chapter 18

value line dividend select november 2014

70 series v8 cruiser manual

who global tb report 2006

earth science guided study workbook answers 14

1989 chevy s10 repair manual 35754

iteration of rational functions x analyt

quizes for bhm109

box cake recipe yellow

1999 2000 buell lightning x1 motorcycle service manual

elasticity sadd solution manual

manual alfa romeo 147 jtd

in search of ancient crete

1986 2015 Harley Davidson Sportster Motorcycle Service Manuals :

turbocharge your writing today request pdf researchgate - May 22 2022

web oct 27 2023 turbocharge your writing career with ai this is the final call and your last chance to take advantage of your special deal where you ll save nearly 700 on our

turbocharge your writing 7 prompt driven improvements for today - Sep 25 2022

web turbocharge your writing online 2 may 2023 9 00am 24 july 2023 5 00pm please note that as this is a premium cdf course you will need to complete at least 75 of the

turbocharge your writing today ideas repec - Mar 20 2022

web oct 29 2021 of course this all means a fatter bottom line which makes you the most popular person in the room if you re ready to acquire near mystical powers of

turbocharge your writing today research flinders - Dec 29 2022

web this article will discuss seven ways to turbocharge your writing with the help of prompt exercises and ai prompt writing prompt writing a breeding ground for creativity

turbocharge your writing today nature - Oct 07 2023

web turbocharge your writing how to become a prolific academic writer authors maria gardiner hugh kearns edition 22

illustrated reprint publisher thinkwell 2010 isbn

50 resources and tools to turbocharge your copywriting skills - Dec 17 2021

turbocharge your writing office of postdoctoral affairs - Aug 25 2022

web jul 1 2011 an auto ethnographic approach is utilised by two doctoral candidates to discuss their experience of the influence of structured peer exchange in their capacity for

turbocharge your writing how to become a prolific academic writer - Jan 30 2023

web mar 30 2023 turbocharge your writing is the ultimate guide to help writers of all levels increase their writing speed and productivity whether you re a professional

turbocharge your writing how to become a prolific - Jul 04 2023

web turbocharging your writing 33 perfectionism situation you ve been working on a difficult part of your thesis for a couple of weeks you ve got a draft but it s not finished it s due

turbocharge your writing by joe vitale open library - Nov 15 2021

final hours turbocharge your writing career with ai - Feb 16 2022

web turbocharge your writing by joe vitale june 1989 awareness pubns edition paperback in english

turbocharge your writing by maria gardiner goodreads - May 02 2023

web reprint reissue date 2016 original date 2010 note cover title fourth reprinting 2016 isbn 9780646537382 0646537385 trade paper

writing skills graduate school career development framework - Jun 22 2022

web corrections all material on this site has been provided by the respective publishers and authors you can help correct errors and omissions when requesting a correction

bestcopyai suite tools - Jan 18 2022

writing productivity apps turbocharge your writing efficiency - Apr 20 2022

web turbocharge your writing with our ai powered tools bestcopy ai let ai create content for blogs articles websites social media and more start free trial

turbocharge your writing how to write faster and boost - Oct 27 2022

web this course will teach you how to maximise your writing output and how to overcome common obstacles that reduce your writing productivity by setting a goal and

[2write](#) - Aug 05 2023

web jan 1 2010 maria gardiner hugh kearns 4 38 13 ratings 2 reviews if you want to be an academic or researcher you have to write and if you want to be a successful academic

[masterclass turbocharge your writing](#) - Jul 24 2022

web sep 29 2023 whether you re a seasoned writer or just starting your writing journey utilizing goal setting apps can revolutionize the way you approach your writing goals

[turbocharge your writing charles darwin university](#) - Jun 03 2023

web podcast from our researcher masterclass turbocharge your academic writing and increase your research output maria gardiner on common challenges and techniques to

turbocharge your writing google books - Sep 06 2023

web may 11 2022 in academia it is often assumed that writing comes naturally however an overwhelming body of research shows that there are very clear and practical strategies

online workshop on turbocharging your writing run eu - Nov 27 2022

web in academia it is often assumed that writing comes naturally however an overwhelming body of research shows that there are very clear and practical strategies that can greatly

turbocharge your academic writing vitae website - Feb 28 2023

web mar 15 2023 turbocharge your writing 24 march 2023 10h00 12h00 cet this workshop will help you understand why it s hard to get started how we deliberately use

hugh kearns ithinkwell com curtin university - Apr 01 2023

web jul 7 2011 turbocharge your writing today maria gardiner hugh kearns research output contribution to journal article peer review 6 citations scopus overview

mi ani gandhi hatya whichissed visionaustralia org - Mar 31 2022

web oct 5 2023 titled gandhi hatya ani mee gandhi assassination and i in october 1967 nathuram godse had his reasons to free books fundamental of fluid mechanics solution manual july 1st 2018 mi ani gandhi hatya fahoy fraction exponents guided notes holes louis sachar collaborative learning standard furniture dimensions in meters

gandhi hatya ani mi theatre play review youtube - May 13 2023

web 43k views 3 years ago nathuramgodse gandhi hatya aani mi drama review in hindi by pratik borade gandhi hatya aani mi theatre play review gandhi hatya ani mi review gandhi

gandhi hatya ani mi makes city proud at state drama fest - Dec 08 2022

web mar 7 2017 chaitanya deshpande tnn mar 7 2017 23 03 ist share aa gandhi hatya ani mi makes city proud at state

drama fest nashik the mainly amateurs gandhi hatya ani mi gandhi s assassination and me has bagged second place at the 56th maharashtra state marathi theatre festival

mi ani gandhi hatya 50storiesfortomorrow ilfu com - Aug 16 2023

web barrage of sound and distractions yet located within the lyrical pages of mi ani gandhi hatya a interesting perform of fictional elegance that pulses with organic thoughts lies an unforgettable trip waiting to be embarked upon written with a virtuoso wordsmith that exciting opus manuals viewers on

gandhi hatya aani mi gopal godse free download borrow - Oct 18 2023

web jul 31 2020 gopal vinayak godse is a convict of gandhi assassination his younger brother nathuram godse killed gandhi in 1948 this book written by gopal godse brings out the facts behind about that incident its consequences upon him his family addeddate 2020 07 31 15 19 32

mi ani gandhi hatya orientation sutd edu sg - Aug 04 2022

web mi ani gandhi hatya demands of india s ani on twitter rahul gandhi ko ei log target kiya hai july 10th 2018 tweet with a location you can add location information to your tweets such as your city or precise location from the web and via third party applications

















mi ani gandhi hatya textra com tw - Feb 10 2023

web 2 mi ani gandhi hatya 2022 05 14 transformations windowing and clipping illumination models and shading algorithms hidden line elimination algorithms curves and fractals the book also focuses on modern concepts like animation and gaming a santali english dictionary oxford university press usa

associate professor anil gandhi monash university malaysia - Jun 02 2022

web sep 30 2020 profile summary dr anil gandhi joined monash university in august 2009 as a clinical associate professor surgery he graduated from christian medical college india in 1980 and obtained his master in surgery from the renowned post graduate institute of medical education research chandigarh india

gandhihatya ani mi     **bookganga** - Mar 11 2023

web     language   7 reviews write a review tell a friend author    category     publication    pages 368 weight 314 gm binding paperback share add to my wishlist not in stock hard copy price 25 off r 100 r 75 0 96 shipping charges will be applicable for this book

mi ani gandhi hatya fahoy pdf sdd tci bio - Jul 15 2023

web mi ani gandhi hatya fahoy asian and african systems of slavery studies in interdisciplinary history conquerors and slaves the medieval and early modern period town and revolution understanding post tonal music the sulu zone 1768 1898 pirates prostitutes and pullers ivory and slaves thomas heatherwick occidental oriental and

mi ani gandhi hatya liululu - Feb 27 2022

web mi ani gandhi hatya fahoy pdf mi ani gandhi hatya fahoy lisamakesyoumove com title mi ani gandhi hatya fahoy keywords get free access to pdf ebook gandhihatya ani mi has 141 ratings and 7 reviews gopal vinayak godse is a convict of gandhi assasination his younger brother nathuram godse killed gandhi in 1948 he has written two books

mi ani gandhi hatya fahoy full pdf gny salvationarmy org - Oct 06 2022

web mi ani gandhi hatya fahoy when people should go to the ebook stores search opening by shop shelf by shelf it is really problematic this is why we allow the ebook compilations in this website it will enormously ease you to see

[mi ani gandhi hatya orientation sutd edu sg](#) - Sep 05 2022

web july 6th 2018 reed mi ani gandhi hatya fahoy retail analytics the secret weapon prayer to st homobonus patron of business clover sites page 2 title la donna silenziosa ebooks free book sanjiv prakashan class 9th passbooks pdf epub june 6th 2018 sanjiv prakashan class 9th passbooks financial

ia903206 us archive org - Jan 09 2023

web type catalog pages 3 0 r endobj 2 0 obj creationdate d 20150806225710 moddate d 20150806225710 producer libtiff tiff2pdf 20100615 creator scanfix tm enhanced endobj 3 0 obj type pages kids 4 0 r 9 0 r 14 0 r 19 0 r 24 0 r 29 0 r 34 0 r 39 0 r 44 0 r 49 0 r 54 0 r 59 0 r 64 0 r 69 0 r 74 0 r 79 0 r 84 0 r 89

[mi ani gandhi hatya rhur impacthub net](#) - May 01 2022

web july 4th 2018 mi ani gandhi hatya fahoy pdf mi ani gandhi hatya fahoy lisamakesyoumove com title mi ani gandhi hatya fahoy keywords get free access to pdf ebook gandhi hatya ani rhur impacthub net 7 47 mi makes city proud at state drama fest march 8th 2017

[gopal godse goodreads](#) - Sep 17 2023

web jul 15 2017 [gopal godse](#) 4 07 230 ratings12 reviews gopal vinayak godse is a convict of gandhi assasination his younger brother nathuram godse killed gandhi in 1948 this book written by gopal godse brings out the facts behind about that incident its consequences upon him his family genres marathi history nonfiction

gandhihatya ani mi paperback bunko 1 january 2016 amazon in - Apr 12 2023

web gandhihatya ani mi paperback bunko 1 january 2016 gopal vinayak godse is a convict of gandhi assasination his younger brother nathuram godse killed gandhi in 1948 this book written by gopal godse brings out the facts behind about that incident its consequences upon him his family

mi ani gandhi hatya fahoy pdf organic plumvillage - Nov 07 2022

web mi ani gandhi hatya fahoy is straightforward in our digital library an online entry to it is set as public thus you can download it instantly our digital library saves in multiple countries allowing you to acquire the most less latency era to

download any of our books when

mi ani gandhi hatya fahoy pivotid uvu edu - Jun 14 2023

web their power to kindle emotions provoke contemplation and ignite transformative change is truly awe inspiring enter the realm of mi ani gandhi hatya fahoy a mesmerizing literary masterpiece penned by a distinguished author guiding readers on a profound journey to unravel the secrets and potential hidden within every word

[mi ani gandhi hatya pqr uiaf gov co](#) - Jul 03 2022

web mi ani gandhi hatya getting the books mi ani gandhi hatya now is not type of challenging means you could not without help going in imitation of books growth or library or borrowing from your contacts to contact them this is an utterly simple means to specifically acquire lead by on line

[tureng fatherland türkçe İngilizce sözlük](#) - Mar 10 2023

web fatherland i ataerkil toplumlarda memleket topraklarına verilen isim fatherland teriminin diğer terimlerle kazandığı İngilizce türkçe sözlükte anlamları 4 sonuç

when to use motherland vs fatherland dictionary com - Jul 14 2023

web jul 2 2019 what are the origins of motherland and fatherland whether a particular group uses their language s equivalent of if they have one motherland or fatherland is a matter of culture tradition or in some instances personal preference in english fatherland is the older of the two

burkhard bilger s book fatherland explores his family s nazi npr - Mar 30 2022

web may 6 2023 npr s scott simon talks with author burkhard bilger about his new book fatherland which explores his family s own nazi past in germany burkhard bilger grew up in a family of german immigrants

manevi turizm ve hac programı fatherland istanbul - Feb 26 2022

web katılıyorumşartlar ve koşullar bir şifre size e posta ile gönderilecek kayıt olmak

fatherland rotten tomatoes - Jul 02 2022

web a u s newswoman miranda richardson teams with an ss detective rutger hauer to solve murders of nazi officials by the gestapo in 1964 berlin rating tvma

fatherland tv movie 1994 imdb - Sep 04 2022

web nov 26 1994 fatherland directed by christopher menaul with rutger hauer miranda richardson peter vaughan michael kitchen in april 1964 more than twenty years after the nazis won world war ii s s officer xavier march uncovers a plot to eliminate the attendees of the wannsee conference so that germany can establish better relations with the u s

profilim fatherland istanbul - Dec 27 2021

web katılıyorumşartlar ve koşullar bir şifre size e posta ile gönderilecek kayıt olmak

why is germany called the fatherland reference com - Jan 28 2022

web apr 4 2020 fatherland brings to mind law government and order and germany is a country that is in favor of these things and is such often referred to as the fatherland fatherland was most commonly used during the time of nazi germany due to the large amount of government power in the country at that time

fatherland 1994 filmi sinemalar com - May 12 2023

web fatherland film konusu 2 dünya savaşı nı almanya kazanmıştır 1964 te başkan kennedy hitler ile barış görüşmeleri için berlin e gelmek üzeredir tam bu sırada ss subayı march amerikalı gazeteci maguire ile birlikte korkunç bir gerçeği ortaya çıkarırlar

fatherland 1994 altyazı - Jan 08 2023

web 2 dünya savaşını almanya kazanmıştır 1964 de başkan kennedy hitler le barış görüşmeleri için berlin e gelmek üzeredir tam bu sırada ss subayı march amerikalı gazeteci maguire ile birlikte korkunç bir gerçeği ortaya çıkarırlar 2 dünya savaşı nı hitler kazansaydı ne

fatherland official teaser trailer youtube - Apr 30 2022

web jul 24 2020 the first official teaser trailer for spellshaw studios film fatherland set to release in summer of 2021

fatherland cambridge İngilizce sözlüğü ndeki anlamı - Jun 01 2022

web fatherland anlam tanım fatherland nedir 1 the country in which you were born or the country with which you feel most connected 2 the daha fazlasını öğren

fatherland novel wikipedia - Aug 15 2023

web fatherland is a 1992 alternative history detective novel by english writer and journalist robert harris set in a universe in which nazi germany won world war ii the story s protagonist is an officer of the kripo the criminal police who is investigating the murder of a nazi government official who participated at the wannsee conference

fatherland where to watch and stream tv guide - Nov 06 2022

web 2 hr 3 mins popular romance novelist rebecca collins is running out of inspiration and concentration to finish her current book her editor decides to send her to a cozy cabin in the country

fatherland asks us to sympathize with a nazi the atlantic - Oct 05 2022

web may 22 2023 the unanswerable philosophical inquiry that floats atop all of fatherland is whether passive resistance in the face of a life threatening force like nazism ought to be categorized as a moral

fatherland film vikipedi - Jun 13 2023

web fatherland stanley weiser ve ron hutchinson tarafından yazılan ve christopher menaul tarafından yönetilen robert harris in aynı isimli 1992 romanının uyarlaması olan 1994 yapımı bir televizyon filmidir yapımcılığını hbo nun üstlendiği filmin

başrollerinde rutger hauer ve miranda richardson yer alıyor

[fatherland 1994 turkcealtyazi.org türkçe altyazı](#) - Feb 09 2023

web nov 26 1994 fatherland 1 shield1963 29 97 441 emrahbozoglu 693 mb 11 yıl önce fatherland 1 shield1963 29 97 353 levanten 1022 92 mb 13 yıl önce İyi yeterli yetersiz değerlendirilmedi kaynak altyazı bekleniyor arşiv bu filmi sevenler şunları da sevdi bilinmeyen yol 2002 ne yerde ne gökte 2015 Ölümsüzler 2011

fatherland by robert harris goodreads - Apr 11 2023

web jan 1 1992 it is april 1964 and one week before hitler s 75th birthday xavier march a detective of the kriminalpolizei is called out to investigate the discovery of a dead body in a lake near berlin s most prestigious suburb

fatherland 1994 turner classic movies - Dec 07 2022

web based on the suspense novel fatherland set in berlin 20 years after a german victory in world war ii an ss detective with the help of an american journalist uncovers a deadly secret of the third reich

[fatherland 1994 film wikipedia](#) - Aug 03 2022

web fatherland is a 1994 american historical drama television film directed by christopher menaul and written by stanley weiser and ron hutchinson based on the 1992 novel of the same title by robert harris the film stars rutger hauer and miranda richardson and aired on hbo on november 26 1994